

® INTERNATIONAL TRADE MARK N° 886239

AUTOHOME®



PRICE LIST SEPTEMBER 2024

AUTOHOME-OFFICIAL.COM

KODAK 400TMY



THE WORLD'S FIRST -



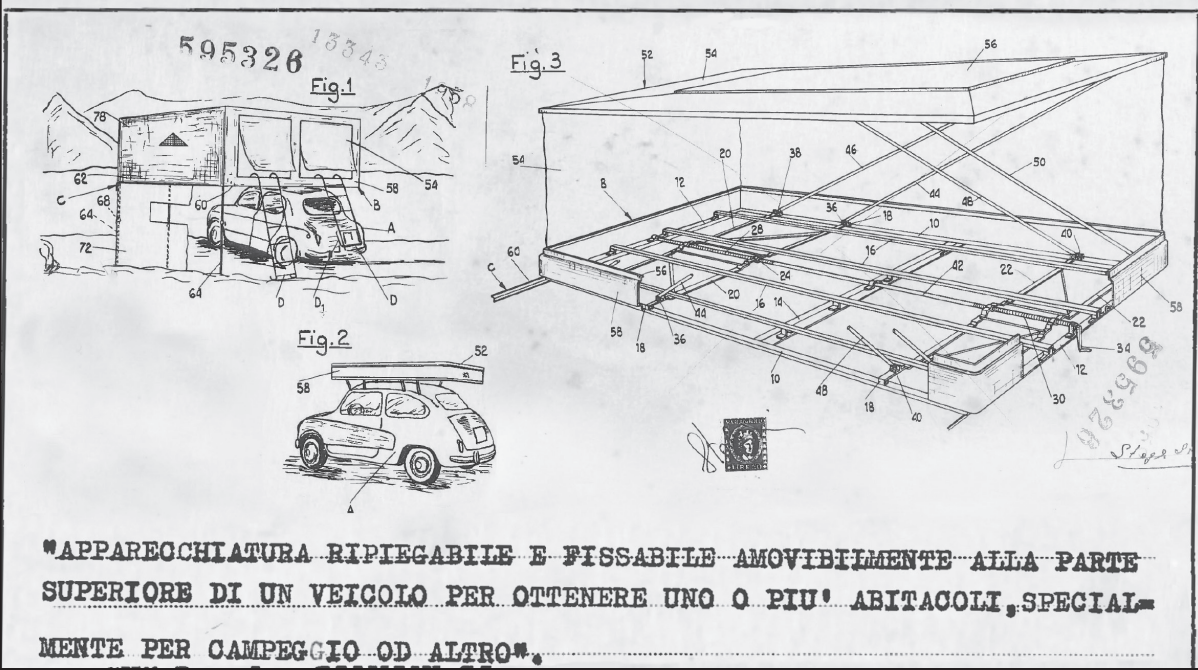

DATING BACK TO 1958

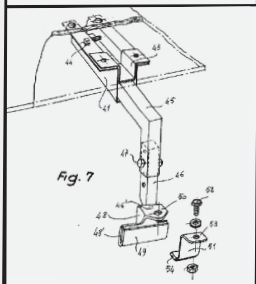
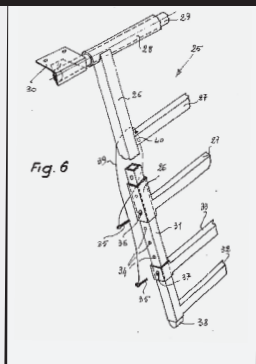
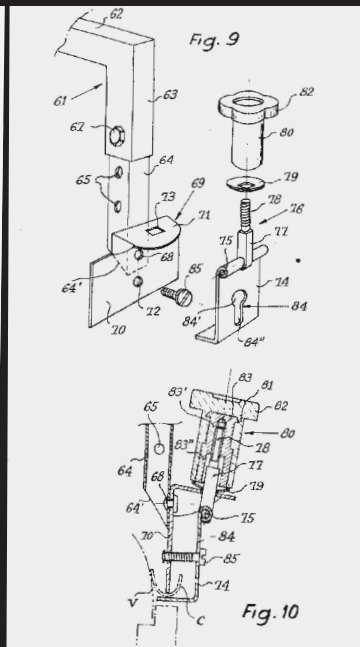
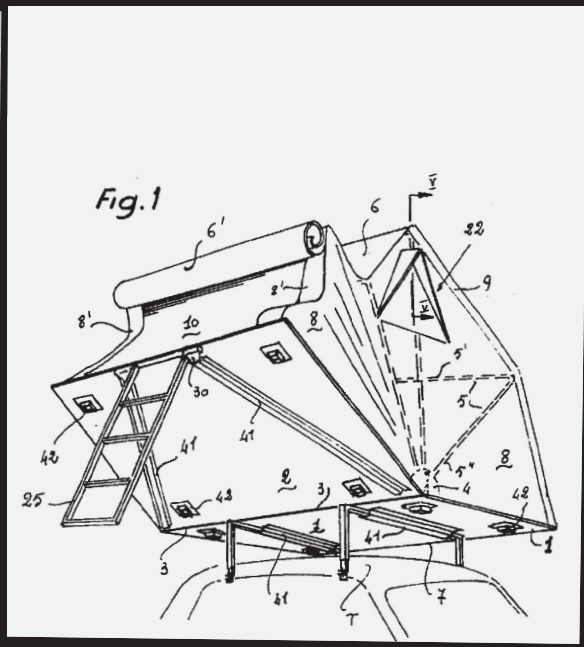

OFFICE
DATA DI
16 SET. 1958
LA UFFICIALE LOGGANTE
Aramis
F.to





IMPORTANT INFORMATION



If you have a tent that fits into the shape of the car when open, you can stop and sleep wherever you want, as it is a kind of parking.



MAGGIOLINA



AIRTOP



COLUMBUS



OVERCAMP



If you have a tent that comes out from the shape of the car when open, you need to go in a camping site or in a private area.



AIR-CAMPING



OVERLAND



OVERZONE



OVERCAMP

PRODUCTS COMPARISON

FEATURES AND EQUIPMENT



The tents used the world over by Tour Leaders and Explorers, for extreme car rallies and expeditions, are identical to the standard production: the same product anybody can buy.

We guarantee that all models of Fiberglass Shell Tents are skilfully constructed entirely by hand. Their composition is very stable and will not weaken or fade over time like common plastic or similar products available on the market. In addition, the composition of glass fibre polyester used, is a perfect insulator from hot and cold environments and if necessary can be easily repaired or painted to colour match your vehicle.

WEIGHT

The GRP (fibreglass) outer shells are all hand made and finished, therefore some variations may appear in the finished weights (Manufacturers tolerance rate is within 5%).

The weight includes high density mattresses 7 cm high and pillows. The weight does not include the ladder that varies according to the height required (ladder about 5 kg).

The weight of the fabric tents includes high-density mattresses 6 cm high, pillows, wings and ladder whose maximum height is 2,35 mt.

The fabric tent floor is made of wood protected by a laminate layer making it perfectly waterproof. It is an elastic and resistant long fibre material withstanding stresses and the weight of the occupants (the floors are not made of polyurethane or coated polystyrene).

The shell products are guaranteed and of **Tüv certified quality**, the manufacturing company is also **ISO 9001** certified.

All Autohome® products are **100% of ITALIAN ORIGIN**, guaranteed by the manufacturer from **2 to 5 YEARS** (see warranty conditions).



ISO 9001:2015



VOLUME

(I*) variable approximate value depending on the model and size which indicates, with the tent closed, the volumetric capacity of the upper shell that allows you to stow: blankets, sleeping bags and night necessities, beauty-cases, bags and accessories for travel.

MORE INFO

For more information, refer to the general use and maintenance instructions that are an integral part of the product.

Visit the company website: autohome-official.com

TYPES OF OPENING



Opening with handle





Automatic opening







Pop-up opening

PRICE LIST AUTOHOME

SEPTEMBER 2024

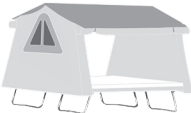
|  | OVERCAMP® | page 188 of the official catalogue | PRICE IN EURO (Vat excluded) |
|---|---|------------------------------------|---------------------------------|
|  | OCG/01 | OVERCAMP SMALL | 1.802,37 |
|  | OCG/03 | OVERCAMP LARGE | 2.054,83 |
| COLOURS, FABRICS AND SPECIFICATIONS | GRAY Walls: 50% Cotton and 50% Polyester. Weight: 420 gr/m2. Roof: BLACK 360 double-sided. | | |
| Serial supplied | 4 universal clamps for fixing to roof racks, 2 windows, 2 large doors with mosquito nets, 1 mattress h 6 with 2-4 pillows 43 x 43, 4 poles to hold up doors and create awnings, 1 PVC tent cover, Wing included, 1 adjustable steel ladder (h closed: 170 cm - h opened: 245 cm). | | |
| Technical data | SMALL: closed 65 x 200 x h 35, open 130 x 200 x h 100. Weight about 54 kg. LARGE: closed 90 x 200 x h 35, open 180 x 200 x h 115. Weight about 66 kg. The laminated and protected bases are made of 7-layer wood fibre, structured to withstand the stresses and weight of the occupants and modular for a diversified installation on the car. Weights include standard accessories and ladder (ladder about 5 kg). | | |

| ACCESSORIES OVERCAMP | page 194 of the official catalogue | | |
|---|------------------------------------|--|--------|
|  | OC/03A | Overcamp Verandah (for car) With adjustable height (car + roof racks = h max 170 cm). | 839,53 |
|  | OC/05A | Awning for Overcamp With adjustable poles applicable to the Overcamp with a zip. Art. OC/05AC: Carbon colour | 353,23 |
|  | OC/06A | Ground feet for Overcamp Specify the tent size when ordering. | 152,72 |
|  | OC/08A | Winter hood for Overcamp Specify the tent size when ordering. | 225,02 |
|  | OC/W01 | Wing | 147,54 |

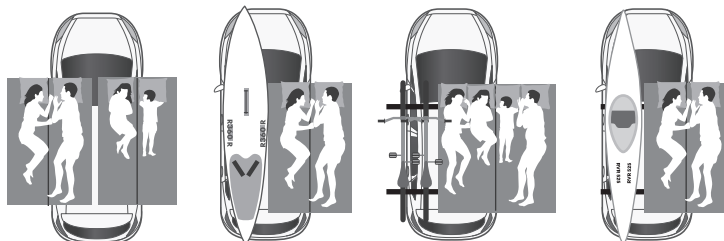

DOUBLE UP

Side positioning:
the tent will occupy only half of the car roof space.
You can fit: Small + Small, Large + Small
or Large + Large on large vehicle.



OVERLAND® • AIR-CAMPING®

page 160 of the official catalogue

PRICE IN EURO
(Vat excluded)

| | | |
|--|---|----------|
| | OLC/01-AC/01 OVERLAND • AIR-CAMPING SMALL | 2.145,00 |
| | OLC/02-AC/02 OVERLAND • AIR-CAMPING MEDIUM | 2.316,31 |
| | OLC/03-AC/03 OVERLAND • AIR-CAMPING LARGE | 2.451,56 |
| COLOURS, FABRICS AND SPECIFICATIONS | <p>OVERLAND: CARBON Walls: 50% Cotton and 50% Polyester. Weight: 420 gr/m2. Roof: BLACK 360 double-sided.</p> <p>AIR-CAMPING: BLU Walls and roof: 50% Cotton and 50% Polyester. Weight: 420 gr/m2. Roof: Gray.</p> | |
| Serial supplied | <p>4 universal clamps for fixing to roof racks, 2 windows, 2 large doors with mosquito nets, 1 mattress h 6 with 2-3-4 pillows 43 x 43, 2 internal pockets, 4 poles to hold up doors and create awnings, 1 PVC tent cover, roof stakes are equipped with anti-condensation covering, Wing included, 1 adjustable aluminium ladder (h closed: 110 cm - h opened: 230 cm).</p> | |
| Technical data | <p>SMALL: closed 130 x 110 x h 35, open 130 x 220 x h 125. Weight about 54 kg. MEDIUM: closed 160 x 110 x h 35, open 160 x 220 x h 125. Weight about 65 kg. LARGE: closed 180 x 110 x h 35, open 180 x 220 x h 125. Weight about 69 kg. The laminated and protected bases are made of wood, a long elastic and resistant fibre that withstands the stresses and weight of the occupants, backbone with high capacity Omega profiles. Weights include standard accessories and ladder (ladder about 5 kg).</p> | |
| PREMIUM PLUS | <p>NEW! PREMIUM PLUS on request with supplement.</p> <ul style="list-style-type: none"> - A special series of tents fitted with a different frame with structural profiles in anti-scratch steel, shaped in OMEGA for a cushioning function. Arranged diagonally under the floor of the tent, they uniformly distribute the weight of the occupants providing for a higher stability to the tent. - STABILIZER BAR Ø 35 x 650 mm welded to the ladder, it furthermore strengthens the frame and the base of the tent at the point where the loads and stresses are concentrated. - LUXURY LADDER in mirror-polished STAINLESS steel, extendable up to 2.30 m, fitted with steps in IROKO wood. Comfortable and non-slip, it does not heat up and burn in the sun. - IROKO: a prestigious tropical wood used in the nautical field water- and moisture-resistant. - Welds made with expensive brass and silver-based alloys which makes the step welding more resistant than the tube itself. - Weights unchanged as the other products of the range. | 507,38 |
| EXPLORER | <p>There are two possibilities to install the tent, according to a "C" guide prearrangement: Standard version (for all models) or Explorer version, (opening and rear entrance). Should you need "C" guides preassembled in Explorer version, please indicate it when ordering, there are no additional charges for this. In this case, article code includes the letter "E" (OLCE/01-OLCE/02-OLCE/03 -ACE/01-ACE/02-ACE/03).</p> | |



OL/04A

Overland Verandah (for car)

With alluminum poles height adjustable (Car + roof racks = h max 170 cm).
Specify the tent size when ordering.

839,53



OL/05A

Winter Hood for Overland / Air-Camping

Specify the tent model and size when ordering.

243,09



OL/06A

Ground feet for Overland / Air-Camping

Specify the tent size when ordering.

152,72



**OL/07A
AC/03A**

Changing Room (for car)

(Car + roof racks = h min cm 155 - h max cm 170.)
Specify the tent model and size when ordering.

366,81



**OL/08A
AC/03F**

Changing Room (for vans, 4WD or high vehicles)

Art. **OL/08A-1 / AC/03F-1**: car + roof racks = h min cm 171 - h max cm 185.
Art. **OL/08A-2 / AC/03F-2**: car + roof racks = h min cm 186 - h max cm 200.
Art. **OL/08A-3 / AC/03F-3**: car + roof racks = h min cm 201 - h max cm 220.
Specify the tent model and size when ordering.

416,51



OL/W01

Wing

114,75



OVERZONE®

page **176** of the official catalogue

PRICE IN EURO
(Vat excluded)

| | | | |
|--|---|------------------------|-----------------|
| | OZ/01 | OVERZONE SMALL | 2.451,56 |
| | OZ/02 | OVERZONE MEDIUM | 2.649,92 |
| | OZ/03 | OVERZONE LARGE | 2.803,20 |
| COLOURS, FABRICS AND SPECIFICATIONS | OLIVE Walls: 50% Cotton and 50% Polyester. Weight: 420 gr/m2. Roof: BLACK 360 double-sided. | | |
| Serial supplied | 4 universal clamps for fixing to roof racks, 2 windows, 2 large doors with mosquito nets, 1 mattress h 6 with 2-3-4 pillows 43 x 43, 2 internal pockets, 4 poles to hold up doors and create awnings, 1 PVC tent cover, roof stakes are equipped with anti-condensation covering, Wing included, 1 adjustable aluminium ladder (h closed: 110 cm - h opened: 230 cm). | | |
| Technical data | SMALL: closed 130 x 110 x h 35, open 130 x 220 + 70 (appendix) x h 125. Weight about 56 kg. MEDIUM: closed 160 x 100 x h 35, open 160 x 220 + 70 (appendix) x h 125. Weight about 65 kg. LARGE: closed 180 x 110 x h 35, open 180 x 220 + 70 (appendix) x h 125. Weight about 74 kg. The laminated and protected bases are made of wood, a long elastic and resistant fibre that withstands the stresses and weight of the occupants, backbone with high capacity Omega profiles. Weights include standard accessories and ladder (ladder about 5 kg). | | |
| PREMIUM PLUS | <p>NEW! PREMIUM PLUS on request with supplement.</p> <ul style="list-style-type: none"> - A special series of tents fitted with a different frame with structural profiles in anti-scratch steel, shaped in OMEGA for a cushioning function. Arranged diagonally under the floor of the tent, they uniformly distribute the weight of the occupants providing for a higher stability to the tent. - STABILIZER BAR Ø 35 x 650 mm welded to the ladder, it furthermore strengthens the frame and the base of the tent at the point where the loads and stresses are concentrated. - LUXURY LADDER in mirror-polished STAINLESS steel, extendable up to 2.30 m, fitted with steps in IROKO wood. Comfortable and non-slip, it does not heat up and burn in the sun. - IROKO: a prestigious tropical wood used in the nautical field water- and moisture-resistant. - Welds made with expensive brass and silver-based alloys which makes the step welding more resistant than the tube itself. - Weights unchanged as the other products of the range. | | 507,38 |
| EXPLORER | There are two possibilities to install the tent, according to a "C" guide prearrangement: Standard version or Explorer version. Should you need "C" guides pre assembled in Explorer version, please indicate it when ordering, there are no additional charges for this. In this case, article code includes the letter "E" (OZE/01-OZE/02-OZE/03). | | |

ACCESSORIES OVERZONE

page **184** of the official catalogue

| | | | |
|--|---------------|---|---------------|
| | OZ/03A | Winter Hood for Overzone Specify the tent size when ordering. | 270,20 |
| | OZ/04A | Changing Room (for cars) (Car + roof racks = h min cm 155 - h max cm 170.) Specify the tent size when ordering. | 505,98 |
| | OZ/05A | Changing Room (for vans, 4WD or high vehicles) Art. OZ/05A-1 : car + roof racks = h min cm 171 - h max cm 185. Art. OZ/05A-2 : car + roof racks = h min cm 186 - h max cm 200. Art. OZ/05A-3 : car + roof racks = h min cm 201 - h max cm 220. Specify the tent size when ordering. | 605,38 |
| | OZ/06A | Ground feet for Overzone Specify the tent size when ordering. | 152,72 |



NOMADLAND®

page **198** of the official catalogue

PRICE IN EURO
(Vat excluded)

| | | | |
|--|--|-----------------------------|-----------------|
| | N/2S | NOMADLAND 2.0 SMALL | 1.522,87 |
| | N/2M | NOMADLAND 2.0 MEDIUM | 1.703,20 |
| | N/2L | NOMADLAND 2.0 LARGE | 1.829,42 |
| COLOURS, FABRICS AND SPECIFICATIONS | BROWN Walls: 100% Polyester. Weight: 255 gr/m2. Roof: BLACK 360 double-sided. | | |
| Serial supplied | 4 universal clamps for fixing to roof racks (including 2 "C" guides oriented for standard mounting), 2 large circular windows on the sides, 1 large roof window with mosquito net and 2 large doors with mosquito nets, 1 mattress h 6 with 2/3/4 pillows 43 x 43, 2 internal pockets, 4 poles to transform the doors into Awnings, Wing included, 1 pvc tent cover, anti-condensation covering on the roof poles, 1 height-adjustable aluminium ladder (h closed: 110 cm - h open: 230 cm). | | |
| Technical data | SMALL: closed 130 x 110 x h 35, open 130 x 220 x h 125. Weight about 54 kg. MEDIUM: closed 160 x 110 x h 35, open 160 x 220 x h 125. Weight about 65 kg. LARGE: closed 180 x 110 x h 35, open 180 x 220 x h 125. Weight about 69 kg. The laminated and protected bases are made of wood, a long elastic and resistant fibre that withstands the stresses and weight of the occupants, backbone with high capacity Omega profiles. Weights include standard accessories and ladder (ladder about 5 kg). | | |
| EXPLORER | Based on the arrangement of the "C" guides, the Tent can be installed in two ways: Standard version (of series for all models) or Explorer. The request for pre-assembled "C" guides in Explorer mode must be made when ordering, without any additional charge. The codes will be distinguished by the addition of the "E" (NE/2S, NE/2M, NE/2L). | | |

ACCESSORIES NOMADLAND

page **200** of the official catalogue

| | | | |
|--|--------|--|---------------|
| | N/203A | Winter Hood for Nomadland 2.0 Specify the tent model and size when ordering. | 243,09 |
| | N/204A | Changing Room (for cars) Car + roof racks = h min cm 155 – h max cm 170) Specify the Tent size when ordering. | 261,47 |
| | N/205A | Changing Room 4x4 (for vans, 4WD or high vehicles) Art. N/205A-1 car + roof racks = h min cm 171 – h max cm 185. Art. N/205A-2 car + roof racks = h min cm 186 – h max cm 200. Art. N/205A-3 car + roof racks = h min cm 201 – h max cm 220. Specify the Tent size when ordering. | 294,26 |
| | N/206A | Ground feet for Nomadland 2.0 Specify the tent size when ordering. | 152,72 |
| | N/W01 | Wing | 114,75 |



AUTOHOME: THE





DESERVED SUCCESS



www.terra.it



AIRTOP®

page **56** of the official catalogue

PRICE IN EURO
(Vat excluded)

| | | | |
|--|---|---------------|----------|
| | ATG/01 | AIRTOP SMALL | 2.675,78 |
| | ATG/02 | AIRTOP MEDIUM | 2.890,94 |
| | ATG/03 | AIRTOP LARGE | 3.054,47 |
| COLOURS, FABRICS AND SPECIFICATIONS | GRAY Walls: TOP AIRTEX® 100% Polyester HI-TECH. | | |
| Serial supplied | 4 universal clamps for fixing to roof racks, 2 doors with partial darkening device, 2 circular windows, 2 anti-condensation aeration inlets, mosquito-netting on windows and doors, anti-condensation and soundproof roof insulation, comfortable storage net, internal elastics for fabric folding, 1 mattress and 2-3-4 pillows, 1 internal LED light, 1 height adjustable aluminium ladder (h closed: 120 cm - h opened: 200 cm), 1 ladder bag. | | |
| Technical data | SMALL: 130 x 210, closed h 33, open h 115. Volume about 271 l*. Weight about 56 kg. MEDIUM: 145 x 210, closed h 33, open h 115. Volume about 305 l*. Weight about 60 kg. LARGE: 160 x 215, closed h 33, open h 115. Volume about 340 l*. Weight about 72 kg. The 2 shells (base and roof) are made of 100% fully insulated fiberglass, AHS® TOP insulation. 4 gas springs with differentiated forces, 400 N and 600 N, with WINDSTOP. Non-deformable mattress with high comfort 7,5 high and 43 x 43 pillows. Weights including standard accessories, ladder excluded (ladder about 5 kg) | | |
| LADDER 4X4 | On request, instead of standard ladder, for SUV and high cars (h closed: 130 cm - h opened: 220 cm). Additional charge. | | 27,07 |
| LADDER EXTRA LONG | On request, instead of standard ladder for vans, 4WD (h closed: 145 cm - h opened: 245 cm). Additional charge. | | 38,53 |



AIRTOP® 360

page **60** of the official catalogue

PRICE IN EURO
(Vat excluded)

| | | | |
|--|---|-------------------|----------|
| | AT360/01 | AIRTOP 360 SMALL | 3.020,04 |
| | AT360/02 | AIRTOP 360 MEDIUM | 3.261,03 |
| | AT360/03 | AIRTOP 360 LARGE | 3.450,37 |
| COLOURS, FABRICS AND SPECIFICATIONS | GRAY Walls: TOP AIRTEX® 100% Polyester HI-TECH. | | |
| Serial supplied | 4 universal clamps for fixing to roof racks, 2 doors with partial darkening device, 6 windows, 2 anti-condensation aeration inlets, mosquito-netting on windows and doors, anti-condensation and soundproof roof insulation, comfortable storage net, internal elastics for fabric folding, 1 mattress and 2-3-4 pillows, 1 internal LED light, 1 height adjustable aluminium ladder (h closed: 120 cm - h opened: 200 cm), 1 ladder bag. | | |
| Technical data | SMALL: 130 x 210, closed h 33, open h 115. Volume about 271 l*. Weight about 56 kg. MEDIUM: 145 x 210, closed h 33, open h 115. Volume about 305 l*. Weight about 60 kg. LARGE: 165 x 215, closed h 33, open h 115. Volume about 340 l*. Weight about 72 kg. The 2 shells (base and roof) are made of 100% fully insulated fiberglass, AHS® TOP insulation. 4 gas springs with differentiated forces, 400 N and 600 N, with WINDSTOP. Non-deformable mattress with high comfort 7,5 high and 43 x 43 pillows. Weights including standard accessories, ladder excluded (ladder about 5 kg) | | |
| BLACK STORM | On request, shells colour Black 360 double-face and textile colour carbon on models Airtop 360 (AT360BS/01, AT360BS/02, AT360BS/03). Additional charge. | | 204,91 |
| HARD FACE | NEW! On request with supplement, matt black shells, sandy finish with scratch-resistant properties and textile colour Black 360 double-face on models Airtop 360 (AT360HF/01, AT360HF/02, AT360HF/03). | | 327,87 |
| LADDER 4X4 | On request, instead of standard ladder, for SUV and high cars (h closed: 130 cm - h opened: 220 cm). Additional charge. | | 27,07 |
| LADDER EXTRA LONG | On request, instead of standard ladder for vans, 4WD (h closed: 145 cm - h opened: 245 cm). Additional charge. | | 38,53 |

(*) Internal capacity of the shells



AIRTOP® PLUS

page 64 of the official catalogue

PRICE IN EURO
(Vat excluded)

| | | | |
|--|---|--------------------|----------|
| | ATPG/01 | AIRTOP PLUS SMALL | 2.847,92 |
| | ATPG/02 | AIRTOP PLUS MEDIUM | 3.071,68 |
| | ATPG/03 | AIRTOP PLUS LARGE | 3.243,81 |
| COLOURS, FABRICS AND SPECIFICATIONS | GRAY Walls: TOP AIRTEX® 100% Polyester HI-TECH. | | |
| Serial supplied | 4 universal clamps for fixing to roof racks, 4 large french windows with partial darkening device, 2 anti-condensation aeration inlets, mosquito-netting on windows and doors, anti-condensation and soundproof roof insulation, comfortable storage net, internal elastics for fabric folding, 1 mattress and 2-3-4 pillows, 1 internal LED light, 1 height adjustable aluminium ladder (h closed: 120 cm - h opened: 200 cm), 1 ladder bag. | | |
| Technical data | SMALL: 130 x 210, closed h 33, open h 115. Volume about 271 l*. Weight about 56 kg. MEDIUM: 145 x 210, closed h 33, open h 115. Volume about 305 l*. Weight about 60 kg. LARGE: 165 x 215, closed h 33, open h 115. Volume about 340 l*. Weight about 72 kg. The 2 shells (base and roof) are made of 100% fully insulated fiberglass, AHS® TOP insulation. 4 gas springs with differentiated forces, 400 N and 600 N, with WINDSTOP. Non-deformable mattress with high comfort 7,5 high and 43 x 43 pillows. Weights including standard accessories, ladder excluded (ladder about 5 kg) | | |
| BLACK STORM | On request, shells colour Black Storm and textile colour carbon on models Airtop Plus (ATPBS/01, ATPBS/02, ATPBS/03). Additional charge. | | 204,91 |
| LADDER 4X4 | On request, instead of standard ladder, for SUV and high cars (h closed: 130 cm - h opened: 220 cm). Additional charge. | | 27,07 |
| LADDER EXTRA LONG | On request, instead of standard ladder for vans, 4WD (h closed: 145 cm - h opened: 245 cm). Additional charge. | | 38,53 |



AUTOHOME® ROOF TENT FOR MINI COUNTRYMAN

page 68 of the official catalogue

PRICE IN EURO
(Vat excluded)

| | | | |
|--|--|---|----------|
| | ATEG/01 | AIRTOP MINI ECO RECYCLED SMALL WHITE SHELLS GRAY TEXTILE | 2.850,36 |
| | ATEB/01 | AIRTOP MINI ECO RECYCLED SMALL BLACK SHELLS BLACK TEXTILE | 3.072,11 |
| COLOURS, FABRICS AND SPECIFICATIONS | GRAY - BLACK Walls: ATLANTIC RECYCLED HIGH-TECH ECO GREEN. | | |
| Serial supplied | 4 universal clamps for attachment to roof bars, 2 doors and 2 windows with mosquito-netting, soundproof and anticondensation roof insulation, storage net, 1 mattress and 2 pillows, 1 internal Led light, 1 4x4 adjustable aluminium ladder, ladder storage bag, internal elastics for fabric folding. | | |
| Technical data | SMALL: 130 x 210, closed h 33, open h 115. Volume about 271 l*. Weight about 56 kg. The 2 shells (base and roof) are made of 100% fully insulated fiberglass, AHS® TOP insulation. 4 gas springs with differentiated forces, 400 N and 600 N, with WINDSTOP. Non-deformable mattress with high comfort 7,5 high and 43 x 43 pillows. Weights including standard accessories, ladder excluded (ladder about 5 kg) | | |

(*) Internal capacity of the shells



MAGGIOLINA® AIRLANDER

page 30 of the official catalogue

PRICE IN EURO
(Vat excluded)

| | | | |
|--|---|-----------------------|----------|
| | MG/09 | AIRLANDER SMALL | 2.649,96 |
| | MG/10 | AIRLANDER MEDIUM | 2.865,12 |
| | MG/11 | AIRLANDER LARGE | 3.028,65 |
| COLOURS, FABRICS AND SPECIFICATIONS | GRAY Walls: 100% Acrylic HI-TECH (DRALON®) - AIRY | | |
| Serial supplied | 4 universal clamps for fixing to roof racks, 1 handle, 2 doors and 2 windows, 1 mattress and 2-3-4 pillows, mosquito nets on all the doors and windows, 1 internal LED light, 1 adjustable aluminium ladder (h closed: 120 cm - h opened: 200 cm), soundproof and anti-condensation roof insulation, 1 ladder bag. | | |
| Technical data | SMALL: 130 x 210, closed h 30, open h 110. Volume about 196 l*. Weight about 59 kg. MEDIUM: 145 x 210, closed h 30, open h 110. Volume about 220 l*. Weight about 64 kg. LARGE: 165 x 215, closed h 30, open h 110. Volume about 260 l*. Weight about 77 kg. SMALL X-LONG: 130 x 230, closed h 30, open h 110. Volume about 210 l*. Weight about 65 kg. MEDIUM X-LONG: 145 x 230, closed h 30, open h 110. Volume about 235 l*. Weight about 70 kg. The 2 shells (base and roof) are made of 100% fully insulated fiberglass, AHS® TOP insulation. Non-deformable mattress with high comfort 7,5 high and 43 x 43 pillows. Weights including standard accessories, ladder excluded (ladder about 5 kg) | | |
| | MP/09 | AIRLANDER PLUS SMALL | 2.890,94 |
| | MP/10 | AIRLANDER PLUS MEDIUM | 3.123,32 |
| | MP/11 | AIRLANDER PLUS LARGE | 3.295,45 |
| COLOURS, FABRICS AND SPECIFICATIONS | GRAY (G) - CARBON (C) The codes will be identified by the addition of the letter corresponding to colour "G" (MPG/09, MPG/10, MPG/11) and colour "C" (MPC/09, MPC/10, MPC/11). Walls: 100% Acrylic HI-TECH (DRALON®) - AIRY | | |
| Serial supplied | 4 universal clamps for fixing to roof racks, 1 handle, 2 doors with daylight screens and 2 windows with mosquito nets, 1 mattress with 2-3-4 pillows, 1 internal LED light, 1 adjustable aluminium ladder (h closed: 120 cm - h opened: 200 cm), soundproof and anti-condensation roof insulation, large roomy storage net, internal elastics for fabric folding, 1 ladder bag. | | |
| Technical data | SMALL: 130 x 210, closed h 30, open h 110. Volume about 196 l*. Weight about 59 kg. MEDIUM: 145 x 210, closed h 30, open h 110. Volume about 220 l*. Weight about 64 kg. LARGE: 160 x 215, closed h 30, open h 110. Volume about 260 l*. Weight about 77 kg. SMALL X-LONG: 130 x 230, closed h 30, open h 110. Volume about 210 l*. Weight about 65 kg. MEDIUM X-LONG: 145 x 230, closed h 30, open h 110. Volume about 235 l*. Weight about 70 kg. The 2 shells (base and roof) are made of 100% fully insulated fiberglass, AHS® TOP insulation. Non-deformable mattress with high comfort 7,5 high and 43 x 43 pillows. Weights including standard accessories, ladder excluded (ladder about 5 kg) | | |
| X-LONG | On request, for vans, hatchbacks, 4WD or high vehicles, Maggiolina Airlander and Airlander Plus (Small-Medium) in the longer model L=230 cm (instead of L=210 cm) - Additional charge. | | 204,91 |
| BLACK STORM | On request, Maggiolina Airlander Plus shells colour Black Storm and textile colour black. | | 204,91 |
| LADDER 4X4 | On request, instead of standard ladder, for SUV and high cars (h closed: 130 cm - h opened: 220 cm). Additional charge. | | 27,07 |
| LADDER EXTRA LONG | On request, instead of standard ladder for vans, 4WD (h closed: 145 cm - h opened: 245 cm). Additional charge. | | 38,53 |

(*) Internal capacity of the shells



MAGGIOLINA® 360 X-LARGE

page **34** of the official catalogue

PRICE IN EURO
(Vat excluded)



MP360/12 AIRLANDER PLUS 360 X-LARGE

4.844,63

COLOURS, FABRICS AND SPECIFICATIONS

BLACK 360 double-sided

Walls: CARBON TOP AIRTEX® 100% Polyester HI-TECH + 360 double-sided.

Serial supplied

4 universal clamps for fixing to roof racks, 1 handle, 2 doors with daylight screens and 6 windows with mosquito nets, 1 mattress with 4 pillows, 1 internal LED light, 1 adjustable aluminium ladder (h closed: 120 cm - h opened: 200 cm), soundproof and anti-condensation roof insulation, large roomy storage net, internal elastics for fabric folding, 1 ladder bag.

Technical data

X -LARGE: 180 x 230, closed h 30, open h 110. Volume about 300 l*. Weight about 90 kg.
The 2 shells (base and roof) are made of 100% fully insulated fiberglass, AHS® TOP insulation.
Non-deformable mattress with high comfort 7,5 high and 43 x 43 pillows.
Weights including standard accessories, ladder excluded (ladder about 5 kg)

BLACK STORM

On request, shells colour Black Storm and textile colour Black 360 double-face on models Airlander Plus (MPBS/09, MPBS/10, MPBS/11) and Airlander Plus 360 X-Large (MP360BS/12). Additional charge.

204,91

LADDER 4X4

On request, instead of standard ladder, for SUV and high cars (h closed: 130 cm - h opened: 220 cm). Additional charge.

27,07

LADDER EXTRA LONG

On request, instead of standard ladder for vans, 4WD (h closed: 145 cm - h opened: 245 cm). Additional charge.

38,53



MAGGIOLINA® GRAND TOUR 360

page **44** of the official catalogue

PRICE IN EURO
(Vat excluded)



M360/15 GRAND TOUR 360 SMALL

3.140,53



M360/16 GRAND TOUR 360 MEDIUM

3.347,09



M360/17 GRAND TOUR 360 LARGE

3.527,83

X-LONG

On request, for vans, hatchbacks, 4WD or high vehicles, Maggiolina Grand Tour and Grand Tour 360 in the longer model L=230 cm (instead of L=210 cm) - Additional charge.

204,91

COLOURS, FABRICS AND SPECIFICATIONS

BLACK 360 double-sided

Walls: CARBON TOP AIRTEX® 100% Polyester HI-TECH + 360 double-sided.

Serial supplied

4 universal clamps for fixing to roof racks, 1 handle, 2 doors with daylight screens and 6 windows with mosquito nets, 1 mattress with 2-3-4 pillows, 1 internal LED light, 1 adjustable aluminium ladder (h closed: 120 cm - h opened: 200 cm), soundproof and anti-condensation roof insulation, large roomy storage net, 1 ladder bag, internal elastics for fabric folding. Configuration to attach the KIT FIX for additional roof racks (for sizes small and medium only).

Technical data

SMALL: 130 x 210, closed h 36, open h 115. Volume about 344 l*. Weight about 60 kg.
MEDIUM: 145 x 210, closed h 36, open h 115. Volume about 378 l*. Weight about 68 kg.
LARGE: 165 x 215, closed h 36, open h 115. Volume about 461 l*. Weight about 76 kg.
SMALL X-LONG: 130 x 230, closed h 36, open h 115. Volume about 358 l*. Weight about 66 kg.
MEDIUM X-LONG: 145 x 230, closed h 36, open h 115. Volume about 393 l*. Weight about 71 kg.
LARGE X-LONG: 165 x 230, closed h 36, open h 115. Volume about 477 l*. Weight about 84 kg.
The 2 shells (base and roof) are made of 100% fully insulated fiberglass, AHS® TOP insulation.
Non-deformable mattress with high comfort 7,5 high and 43 x 43 pillows.
Weights including standard accessories, ladder excluded (ladder about 5 kg)

BLACK STORM

On request, shells colour Black Storm and textile colour Black 360 double-face, on models Maggiolina Grand Tour 360 (M360BS/15, M360BS/16, M360BS/17). Additional charge.

204,91

HARD FACE

NEW! On request with supplement, matt black shells, sandy finish with scratch-resistant properties and textile colour Black 360 double-face on models Grand Tour 360 (M360HF/15, M360HF/16, M360HF/17)

327,87

LADDER 4X4

On request, instead of standard ladder, for SUV and high cars (h closed: 130 cm - h opened: 220 cm). Additional charge.

27,07

LADDER EXTRA LONG

On request, instead of standard ladder for vans, 4WD (h closed: 145 cm - h opened: 245 cm). Additional charge.

38,53



MAGGIOLINA® EXTREME

page 36 of the official catalogue

PRICE IN EURO
(Vat excluded)

| | | | |
|--|--|----------------------------|----------|
| | MBS/05 | EXTREME SMALL BLACK STORM | 3.183,57 |
| | MBS/06 | EXTREME MEDIUM BLACK STORM | 3.433,15 |
| COLOURS, FABRICS AND SPECIFICATIONS | CARBON Walls: 100% Acrylic HI-TECH (DRALON®) – AIRY | | |
| Serial supplied | 2 adjustable bars on the tent roof, 4 universal clamps for fixing to roof racks, 1 handle, 2 doors with daylight screens and 2 windows, mosquito nets on all the doors, 1 mattress and 2-3 pillows, 1 internal LED light, soundproof and anti-condensation roof insulation, 1 adjustable aluminium ladder (h closed: 120 cm - h opened: 200 cm), large roomy storage net, internal elastics for fabric folding, 1 ladder bag. | | |
| Technical data | SMALL: 130 x 210, closed h 33, open h 115. Volume about 203 l*. Weight about 64 kg. MEDIUM: 145 x 210, closed h 33 cm, open h 115. Volume about 228 l*. Weight about 68 kg. The 2 shells (base and roof) are made of 100% fully insulated fiberglass, AHS® TOP insulation. Non-deformable mattress with high comfort 7,5 high and 43 x 43 pillows. Weights including standard accessories, ladder excluded (ladder about 5 kg) | | |
| HARD FACE | NEW! On request with supplement, matt black shells, sandy finish with scratch-resistant properties and textile colour Black on models Extreme (MHF/05, MHF/06). | | 327,87 |



MAGGIOLINA® CARBON FIBER

page 26 of the official catalogue

PRICE IN EURO
(Vat excluded)

| | | | |
|--|---|--------------------------------|----------|
| | MCF/01 | MAGGIOLINA CARBON FIBER SMALL | 5.010,48 |
| | MCF/02 | MAGGIOLINA CARBON FIBER MEDIUM | 5.837,42 |
| COLOURS, FABRICS AND SPECIFICATIONS | MAGGIOLINA CARBON FIBER Walls: 100% Acrylic HI-TECH (DRALON®) – AIRY | | |
| Serial supplied | Carbon fiber shells for maximum resistance and lightness, 4 universal clamps for fixing to roof racks, 1 handle, 2 doors with daylight screens and 2 windows with mosquito nets, 1 mattress with 2-3 pillows, 1 internal LED light, 1 adjustable aluminium ladder (h closed: 120 cm - h opened: 200 cm), soundproof and anti-condensation roof insulation, large roomy storage net, internal elastics for fabric folding, 1 ladder bag. | | |
| Technical data | SMALL: 130 x 210, closed h 30, open h 110. Volume about 196 l*. Weight about 51 kg. MEDIUM: 145 x 210, closed h 30, open h 110. Volume about 220 l*. Weight about 57 kg. The 2 shells (base and roof) are made of 100% fully carbon fiber, AHS® TOP insulation. Non-deformable mattress with high comfort 7,5 high and 43 x 43 pillows. Weights including standard accessories, ladder excluded (ladder about 5 kg) | | |
| LADDER 4X4 | On request, instead of standard ladder, for SUV and high cars (h closed: 130 cm - h opened: 220 cm). Additional charge. | | 27,07 |
| LADDER EXTRA LONG | On request, instead of standard ladder for vans, 4WD (h closed: 145 cm - h opened: 245 cm). Additional charge. | | 38,53 |

(*) Internal capacity of the shells



AIR-SKY® 360

page 48 of the official catalogue

PRICE IN EURO
(Vat excluded)

| | | | |
|--|---|--------------------|----------|
| | AS360/01 | AIR-SKY 360 SMALL | 3.553,65 |
| | AS360/02 | AIR-SKY 360 MEDIUM | 3.786,03 |
| | AS360/03 | AIR-SKY 360 LARGE | 3.992,58 |
| COLOURS, FABRICS AND SPECIFICATIONS | BLACK 360 double-sided Walls: CARBON TOP AIRTEX® 100% Polyester HI-TECH + 360 double-sided. | | |
| Serial supplied | 4 universal clamps for fixing to roof racks, 1 handle for opening and closing, 2 doors with with arched zippers for partial opening and 6 windows, mosquito nets on all openings, 1 mattress with 2/3/4 pillows, 2 ventilation openings on the doors, 1 storage net, 1 internal LED light, internal elastics for textile folding, 1 aluminium adjustable aluminium ladder (h closed: 120 cm - h open: 200 cm) foldable during travel, ladder bag, soundproof and anticondensation roof. BUS LUXURY with aluminium frame 70x60 cm allows partial openings (anticondensation or for airing) and at 90° to for standing up inside the Tent and look out from the opening, mosquito net and black out curtain are included. | | |
| Technical data | SMALL: 130 x 210, closed h 35, open h 125. Volume about 236 l*. Weight about 67 kg. MEDIUM: 145 x 210, closed h 35, open h 125. Volume about 260 l*. Weight about 73 kg. LARGE: 165 x 215, closed h 35, open h 125. Volume about 286 l*. Weight about 85 kg. SMALL X-LONG: 130 x 230, closed h 35, open h 125. Volume about 245 l*. Weight about 73 kg. MEDIUM X-LONG: 145 x 230, closed h 35, open h 125. Volume about 275 l*. Weight about 82 kg. The 2 shells (base and roof) are made of 100% fully insulated fiberglass, AHS® TOP insulation. Non-deformable mattress with high comfort 7,5 high and 43 x 43 pillows. Weights including standard accessories, ladder excluded (ladder about 5 kg) | | |
| BLACK STORM | On request, shells colour Black Storm and textile colour Black 360 double-face on models Air-Sky 360 (AS360BS/01 - AS360BS/02 - AS360BS/03). Additional charge. | | 204,91 |
| HARD FACE | NEW! On request with supplement, matt black shells, sandy finish with scratch-resistant properties and textile colour Black 360 double-face on models Air-Sky (AS360HF/01, AS360HF/02, AS360HF/03). | | 327,87 |
| X-LONG | On request, for vans, hatchbacks, 4WD or high vehicles, Air-Sky 360 (Small-Medium) in the longer model L=230 cm (instead of L=210 cm) - Additional charge. | | 204,91 |
| LADDER 4X4 | On request, instead of standard ladder, for SUV and high cars (h closed: 130 cm - h opened: 220 cm). Additional charge. | | 27,07 |
| LADDER EXTRA LONG | On request, instead of standard ladder for vans, 4WD (h closed: 145 cm - h opened: 245 cm). Additional charge. | | 38,53 |

(*) Internal capacity of the shells

| | | | |
|---|----------------|--|-----------------|
|  | M/05A | Maggiolina Verandah (for cars) With aluminium poles height adjustable. (Car + roof racks = h min cm 155 - h max cm 170). | 839,53 |
|  | M/06A | Maggiolina Verandah 4x4 With aluminium poles height adjustable. (Car + roof racks = h min cm 171 - h max cm 220). | 1.006,71 |
|  | M/09A | Ground Feet for Maggiolina / Airtop | 143,69 |
|  | M/10A | Winter Hood for Maggiolina / Airtop Specify the tent model and size when ordering. | 215,98 |
|  | M/11A-1 | Awning Maggiolina (for cars) Can be applied to the favourite side. (Car + roof racks = h min cm 150 - h max cm 185). | 227,64 |
|  | M/11A-2 | Awning Maggiolina 4X4 Can be applied to the favourite side. (Car + roof racks = h min cm 186 - h max cm 240). | 247,52 |
|  | M/12A | Changing Room (for cars) Additional area closed on all 4 sides. Can be applied to the favourite side. Aluminium adjustable poles. Available in Gray colour. (Car + roof racks = h min cm 155 - h max cm 170). Specify the year of production of the tent. | 555,68 |
|  | M/13A | Changing Room 4X4 Art. M/13A-1: car + roof racks = h min cm 171 - h max cm 185. Art. M/13A-2: car + roof racks = h min cm 186 - h max cm 200. Art. M/13A-3: car + roof racks = h min cm 201 - h max cm 220. Additional area closed on all 4 sides. Can be applied to the favourite side. Aluminium adjustable poles. Available in Carbon colour. Specify the year of production of the tent. | 655,08 |
|  | M/W01 | Wing Black Entrance protection. 1 in Black colour. | 130,32 |
|  | K/F | KIT FIX To fix additional bars on the upper shell (package for 4 fixing points). Only on Grand Tour and Grand Tour 360 Small and Medium. | 62,35 |



COLUMBUS® CLASSIC

page 102 of the official catalogue

PRICE IN EURO
(Vat excluded)

| | | | |
|--|--|-------------------------|----------|
| | CG/01 | COLUMBUS CLASSIC SMALL | 2.632,75 |
| | CG/02 | COLUMBUS CLASSIC MEDIUM | 2.847,92 |
| | CG/03 | COLUMBUS CLASSIC LARGE | 3.011,43 |
| COLOURS, FABRICS AND SPECIFICATIONS | GRAY Walls: TOP AIRTEX® 100% Polyester HI-TECH. | | |
| Serial supplied | 4 Universal clamps for fixing to roof racks, 2 doors, windows with mosquito nets, 1 large window on the rear side, 1 mattress, 2-3-4 pillows, 2 air vents complete with mosquito net, large roomy storage net, 1 internal LED light, 1 adjustable aluminium ladder (h closed: 120 cm - h opened: 200 cm), soundproof and anti-condensation roof insulation, internal elastics for textile folding, 1 ladder bag. | | |
| Technical data | SMALL: 130 x 210, closed h 30, open h 150. Volume about 196 l*. Weight about 56 kg. MEDIUM: 145 x 210, closed h 30, open h 150. Volume about 220 l*. Weight about 60 kg. LARGE: 165 x 215, closed h 30, open h 150. Volume about 260 l*. Weight about 71 kg. SMALL X-LONG: 130 x 230, closed h 30, open h 150. Volume about 210 l*. Weight about 58 kg. MEDIUM X-LONG: 145 x 230, closed h 30, open h 150. Volume about 235 l*. Weight about 67 kg. The 2 shells (base and roof) are made of 100% fully insulated fiberglass, AHS® TOP insulation. 2 gas springs with differentiated forces, 400 N and 600 N, with WINDSTOP. Non-deformable mattress with high comfort 7,5 high and 43 x 43 pillows. Weights including standard accessories, ladder excluded (ladder about 5 kg) | | |
| X-LONG | On request, for vans, hatchbacks, 4WD or tall vehicles, Columbus (Small-Medium) in the longer model L=230 cm (instead of L=210 cm) - Additional charge. | | 204,91 |



COLUMBUS® CARBON FIBER

page 112 of the official catalogue

PRICE IN EURO
(Vat excluded)

| | | | |
|--|--|------------------------------|----------|
| | CCF/01 | COLUMBUS CARBON FIBER SMALL | 4.961,92 |
| | CCF/02 | COLUMBUS CARBON FIBER MEDIUM | 5.812,11 |
| COLOURS, FABRICS AND SPECIFICATIONS | CARBON Walls: TOP AIRTEX® 100% Polyester HI-TECH. | | |
| Serial supplied | Carbon fiber shells for maximum resistance and lightness, 4 universal clamps for fixing to roof racks, 2 doors, 2 windows with mosquito nets, 1 mattress, 2-3 pillows, 2 air vents complete with mosquito net, large roomy storage net, 1 internal LED light, 1 large opening on the rear side complete with mosquito net and roll up-roll down and additional textile with CRISTAL window, 1 adjustable aluminium ladder (h closed: 120 cm - h opened: 200 cm), soundproof and anti-condensation roof insulation, internal elastics for textile folding, 1 ladder bag, Air Climate anti-condensation. | | |
| Technical data | SMALL: 130 x 210, closed h 30, open h 150. Volume about 196 l*. Weight about 44 kg. MEDIUM: 145 x 210, closed h 30, open h 150. Volume about 220 l*. Weight about 51 kg. The 2 shells (base and roof) are made of 100% fully carbon fiber, AHS® TOP insulation. 2 gas springs with differentiated forces, 400 N and 600 N, with WINDSTOP. Non-deformable mattress with high comfort 7,5 high and 43 x 43 pillows. Weights including standard accessories, ladder excluded (ladder about 5 kg) | | |
| LADDER 4X4 | On request, instead of standard ladder, for SUV and high cars (h closed: 130 cm - h opened: 220 cm). Additional charge. | | 27,07 |
| LADDER EXTRA LONG | On request, instead of standard ladder for vans, 4WD (h closed: 145 cm - h opened: 245 cm). Additional charge. | | 38,53 |

(*) Internal capacity of the shells



COLUMBUS® VARIANT

page 106 of the official catalogue

PRICE IN EURO
(Vat excluded)

| | | | |
|--|---|--------------------------|----------|
| | CV/01 | COLUMBUS VARIANT SMALL | 2.908,15 |
| | CV/02 | COLUMBUS VARIANT MEDIUM | 3.140,53 |
| | CV/03 | COLUMBUS VARIANT LARGE | 3.321,27 |
| | CV/04 | COLUMBUS VARIANT X-LARGE | 4.552,01 |
| COLOURS, FABRICS AND SPECIFICATIONS | GRAY (G) – CARBON (C) The codes will be identified with the letter corresponding to the colour "G"(CVG/01, CVG/02, CVG/03, CVG/04) - "C" (CVC/01, CVC/02, CVC/03, CVC/04). | | |
| Serial supplied | 4 Universal clamps for fixing to roof racks, 2 doors, windows with mosquito nets, 1 mattress, 2-3-4 pillows, 2 air vents complete with mosquito net, large roomy storage net, 1 internal LED light, 1 large opening on the rear side complete with mosquito net and roll up-roll down and additional textile with CRISTAL window, 1 adjustable aluminium ladder (h closed: 120 cm - h opened: 200 cm), soundproof and anti-condensation roof insulation, internal elastics for textile folding, 1 ladder bag, Air Climate anti-condensation. Configuration to attach the kit fix for additional roof bars (for sizes Small and Medium only). Wing included. | | |
| Technical data | SMALL: 130 x 210, closed h 30, open h 150. Volume about 196 l*. Weight about 56 kg. MEDIUM: 145 x 210, closed h 30, open h 150. Volume about 220 l*. Weight about 60 kg. LARGE: 165 x 215, closed h 30, open h 150. Volume about 260 l*. Weight about 71 kg. SMALL X-LONG: 130 x 230, closed h 30, open h 150. Volume about 210 l*. Weight about 58 kg. MEDIUM X-LONG: 145 x 230, closed h 30, open h 150. Volume about 235 l*. Weight about 67 kg. X-LARGE: 180 x 230, closed h 30, open h 150. Volume about 300 l*. Weight about 93 kg. The 2 shells (base and roof) are made of 100% fully insulated fiberglass, AHS® TOP insulation. 2 gas springs with differentiated forces, 400 N and 600 N, with WINDSTOP. Non-deformable mattress with high comfort 7,5 high and 43 x 43 pillows. Weights including standard accessories, ladder excluded (ladder about 5 kg) | | |
| X-LONG | On request, for vans, hatchbacks, 4WD or tall vehicles, Columbus Variant (Small-Medium) in the longer model L=230 cm (instead of L=210 cm) - Additional charge. Columbus models in X-Long size are not configured for the application of Kit Fix. | | 204,91 |
| BLACK STORM | On request, shells colour Black Storm and textile colour carbon, on models Columbus Variant (CVBS/01, CVBS/02, CVBS/03, CVBS/04). Additional charge. | | 204,91 |
| HARD FACE | NEW! On request with supplement, matt black shells, sandy finish with scratch-resistant properties and textile colour carbon on models Columbus Variant (CVHF/01, CVHF/02, CVHF/03, CVHF/04). | | 327,87 |



AUTOHOME® X LAND ROVER

page 118 of the official catalogue

PRICE IN EURO
(Vat excluded)

| | | | |
|--|---|------------------------------------|----------|
| | CO/LR | AUTOHOME X LAND ROVER SMALL X-LONG | 3.400,94 |
| COLOURS, FABRICS AND SPECIFICATIONS | CARBON Walls: TOP AIRTEX® 100% Polyester HI-TECH. | | |
| Serial supplied | 4 universal clamps for attachment to Landrover Expedition Roof Rack, 2 doors and 2 windows with mosquito-netting, big rear door, soundproof and anticondensation roof insulation, storage net, 1 mattress and 2 pillows, interior led light, 1 adjustable Extralong aluminium ladder, ladder storage bag, internal elastics for fabric folding. | | |
| Technical data | SMALL X-LONG: 130 x 230, closed h 33, open h 150. Volume about 271 l*. Weight about 58 kg. The 2 shells (base and roof) are made of 100% fully insulated fiberglass, AHS® TOP insulation. 2 gas springs with differentiated forces, 400 N and 600 N, with WINDSTOP. Non-deformable mattress with high comfort 7,5 high and 43 x 43 pillows. Weights including ACCESSORIES, ladder excluded (ladder about 5 kg). | | |

(*) Internal capacity of the shells

| | | | |
|---|-----------------------|---|----------------------|
|  | <p>C/W01</p> | <p>Wing Columbus A further protection to enjoy your stay in the tent even in the event of bad weather. All openings, the side entrances and the tailgate, are covered and can remain open when it rains. Specify the year of production of the tent.</p> | <p>204,89</p> |
|  | <p>C/03A</p> | <p>Columbus Verandah (for cars) With aluminium poles height adjustable (car + roof racks = h min cm 155 - h max cm 170).</p> | <p>881,50</p> |
|  | <p>C/04A</p> | <p>Winter Hood for Columbus Specify the tent size when ordering.</p> | <p>215,98</p> |
|  | <p>C/05A-1</p> | <p>Awning Columbus (for cars) (Car + roof racks = h min cm 150 - h max cm 185). Can be applied to the left side. On request for right side.</p> | <p>283,71</p> |
|  | <p>C/05A-2</p> | <p>Awning Columbus 4x4 (Car + roof racks = h min cm 186 - h max cm 240). Can be applied to the left side. On request for right side.</p> | <p>302,69</p> |
|  | <p>C/06A</p> | <p>Ground Feet for Columbus</p> | <p>143,69</p> |
|  | <p>K/F</p> | <p>KIT FIX To fix additional bars on the upper shell (package for 4 fixing points). Only on Columbus Variant Small and Medium.</p> | <p>62,35</p> |



AUTOHOME:







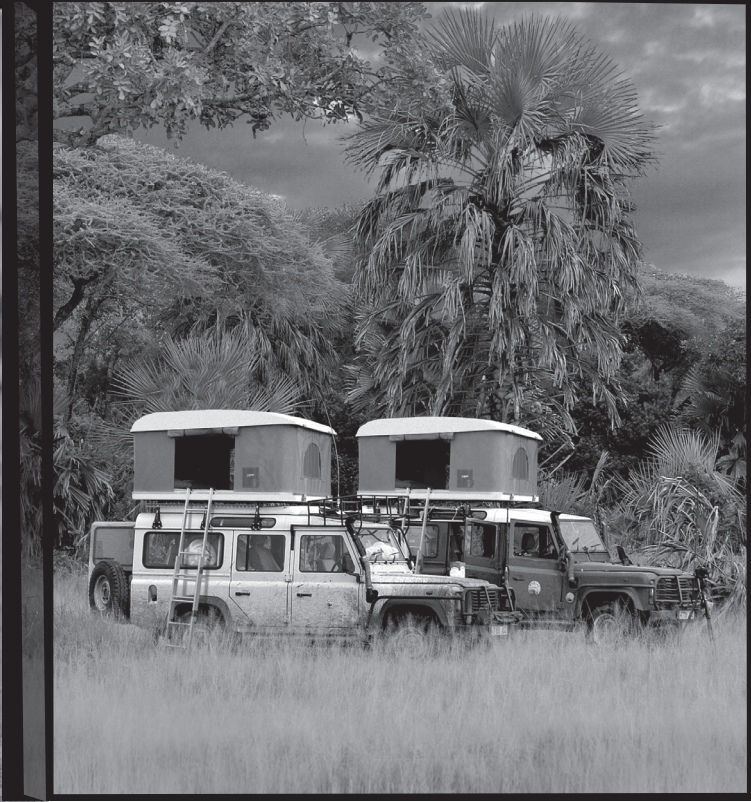

AN ITALIAN HISTORY

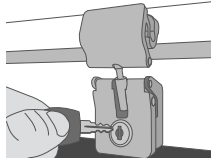
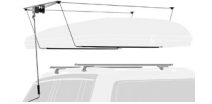

UNIVERSAL ACCESSORIES

page 214 of the official catalogue

PRICE IN EURO
(Vat excluded)

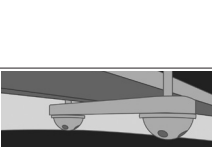
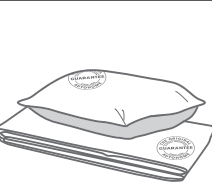
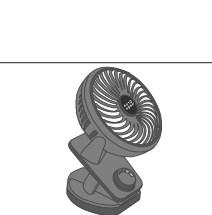
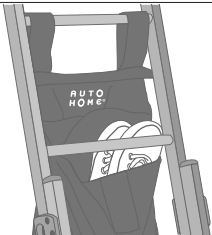
| | | | |
|---|--------------------------|---|--------|
|  | KEY CLOSURE C-100 | Key closure 1 Closure complete with key with clasp and fixing screws. Specify silver or black colour when ordering. The closure must be placed in the same position as the one set up as standard. | 29,85 |
|  | K/15A | Space Saving Kit Can be used for all the models, except X-Large sizes. | 117,48 |
|  | R/TOPS-S | Rolling Top Soft (cm 200 x 250 extension) with fixing Kit Standard. | 296,64 |
|  | ACS-3DS | Wired Mattress under frame - Small and Small X-Long (rolls) Specify the tent model when ordering. | 103,10 |
| | ACS-3DM | Wired Mattress under frame - Medium and Medium X-Long (rolls) Specify the tent model when ordering. | 113,51 |
| | ACS-3DL | Wired Mattress under frame - Large and Large X-Long (rolls) Specify the tent model when ordering. | 123,93 |
| | ACS-3DXL | Wired Mattress under frame - X-Large (rolls) Specify the tent model when ordering. | 134,34 |
|  | O/S-S | Kit Comfort Plus Small and Small X-Long (Orthopaedic Springs + Mattress) Specify the tent model and size when ordering. | 387,68 |
| | O/S-M | Kit Comfort Plus Medium and Medium X-Long (Orthopaedic Springs + Mattress) Specify the tent model and size when ordering. | 424,46 |
| | O/S-L | Kit Comfort Plus Large and Large X-Long (Orthopaedic Springs + Mattress) Specify the tent model and size when ordering. | 497,03 |
| | O/S-XL | Kit Comfort Plus X-Large (Orthopaedic Springs + Mattress) Specify the tent model and size when ordering. | 533,81 |
|  | K/16A | Universal Anti-theft Kit | 79,53 |
|  | K/N-S | Kit Night for Small and Small X-Long models 1 mattress cover with elastic corners, 1 bed sheet, 2 pillowcases (100% cotton, colour pearl gray). Specify the tent model and size when ordering. | 132,21 |
| | K/N-M | Kit Night per Medium and Medium X-Long 1 mattress cover with elastic corners, 1 bed sheet, 3 pillowcases (100% cotton, colour pearl gray). Specify the tent model and size when ordering. | 168,99 |
| | K/N-L | Kit Night for Large, Large X-Long and X-Large models 1 mattress cover with elastic corners, 1 bed sheet, 4 pillowcases (100% cotton, colour pearl gray). Specify the tent model and size when ordering. | 193,84 |
|  | K/A | Kit Air Fan to improve air-circulation inside the Tent. | 49,70 |
|  | R/P | Roll-Up Pockets Comfortable universal pockets that can be closed with Velcro. Waterproof and easy to place, they can contain slippers, shoes, camping accessories or personal effects. Material: 100% Nylon. | 31,97 |

POSITIONING ON THE VEHICLE

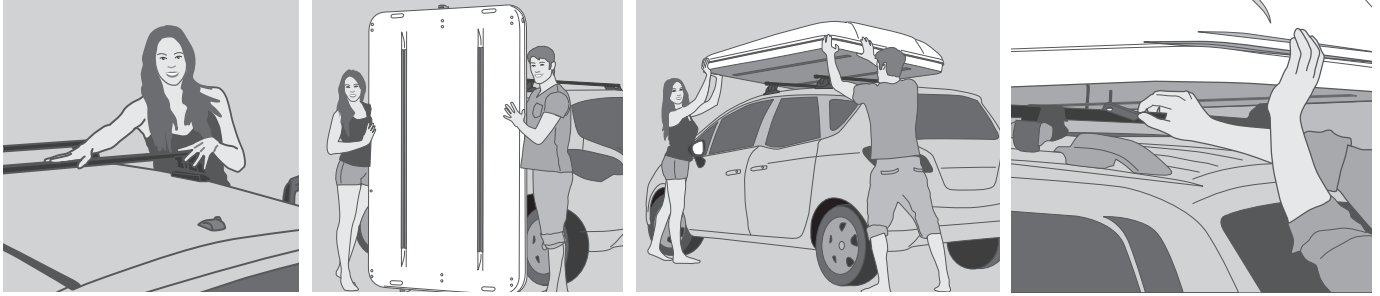

The exclusive Autohome fixing system, with 2 “C” guide rods in the base, allows the tent to be fitted to any vehicle roof: family car, off-road, station-wagon with railing, SUV, camper, van, pick-up, sheeted vehicle, truck... Quick and safe, the system has 4 adjustable clamps – a standard feature – to position and secure the tent as required on any roof or railing, without risk and without needing to change the bodywork.

For further information or clarification get in touch. Our Customer Service Department is at your disposal.

AUTOHOME - Viale Risorgimento, 23 - 46017 Rivarolo Mantovano (MN) Italy

Tel. +39.0376.99590 - +39.0376.958164 - Fax +39.0376.958088 - e-mail: info@autohome.it

SPARE PARTS

PRICE LIST FOR SPARE PARTS ON REQUEST

- Repairs can be carried directly by the Manufacturer only in the winter months from SEPTEMBER to January; customers should bear this in mind and plan accordingly. Repairs are paid in advance based on the estimate.

- Customers should pick up the repaired item at their own expense within 20 days of notification of completed reparation.

- Failing this, the manufacturer may require an indemnity for prolonged storage.

PACKING AND DELIVERY

All roof tent models are delivered in sturdy cardboard packing protected inside with polystyrene.

| ART. | MODELL | GRÖSSE | VERPACKUNG |
|--|--|---------------|---------------|
| OCG/01 | Overcamp | Small | 202x39x77 cm |
| OCG/02 | Overcamp | Medium | 202x39x99 cm |
| OLC/01 - AC/01 - OZ/01 | Overland - Air-Camping - Overzone - No-madland | Small | 138x39x118 cm |
| OLC/02 - AC/02 - OZ/02 | Overland - Air-Camping - Overzone - No-madland | Medium | 168x39x118 cm |
| OLC/03 - AC/03 - OZ/03 | Overland - Air-Camping - Overzone - No-madland | Large | 188x39x118 cm |
| CV/01 - CCF/01 | Columbus Variant / Columbus Carbon Fiber | Small | 223x39x135 cm |
| CV/02 - CCF/02 | Columbus Variant / Columbus Carbon Fiber | Medium | 223x39x154 cm |
| CV/03 | Columbus Variant large | Large | 222x39x175 cm |
| CV/01 XL - CO/LR | Columbus Variant / Land Rover | Small X-Long | 240x39x135 cm |
| CV/02 XL | Columbus Variant | Medium X-Long | 240x39x154 cm |
| CV/04 | Columbus Variant | X-Large | 248x48x202 cm |
| MG/09 - MP/09 - MBS/05 - M360/15 - MCF/01 - AS360/01 | Maggiolina / Air Sky | Small | 223x39x135 cm |
| MG/10 - MP/10 - MBS/06 - M360/16 - MCF/02 - AS360/02 | Maggiolina / Air Sky | Medium | 223x39x154 cm |
| MG/11 - MP/11 - M360/17 - AS360/03 | Maggiolina / Air Sky | Large | 223x39x175 cm |
| M360/17 XL | Grand Tour 360 | Large X-Long | 248x48x202 cm |
| MG/09 XL - MP/09 XL - M360/15XL - AS360/01XL | Maggiolina / Air Sky | Small X-Long | 243x37x136 cm |
| MG/10 XL - MP/10 XL - M360/16XL - AS360/02XL | Maggiolina / Air Sky | Medium | 243x37x155 cm |
| MP360/12 | Maggiolina Airlander Plus 360 X-Large | X-Large | 248x48x202 cm |
| ATG/01 - AT360/01 - ATPG/01 - ATE/01 | AirTop / MINI | Small | 223x39x135 cm |
| ATG/02 - AT360/02 - ATPG/02 | AirTop | Medium | 223x39x154 cm |
| ATG/03 - AT360/03 - ATPG/03 | AirTop | Large | 223x39x175 cm |

Packaging weight with pallet: Small ≈110 kg - Medium ≈135 kg - Large ≈145 kg
Packaging weight with wooden case: Large X-Long ≈134 kg - X-Large ≈ 140 kg

GENERAL

CONDITIONS

PRICES: Every quotation given in the catalog is subject to change without any obligation to give prior notice. The VAT is included in the goods' ex-factory price at Rivarolo Mantovano.

DELIVERY: The delivery terms are merely indicative. Any delays shall not be a cause for cancellations and/or indemnities of any sort and shall not entail any liability of the seller.

TRANSPORT: Upon receiving the goods, the Client is obliged to check the integrity and/or mishandling of the packaging and/or the possible lack of batches, with the obligation to immediately notify the carrier before the release of the goods, through a signed annotation on the bill of; if this procedure is not followed, no reimbursement will be given. Incomplete shipments with missing accessories if requested, due to the lack of warehouse availability, shall not give rise to complaints or indemnities of any sort. Returned goods will not be accepted without a written authorization of the Seller. If the goods dispatched will not be released, all the expenses shall be borne by the Client.

PAYMENTS: Except for particular agreements, the payments shall have to be made directly to the Seller. The down payments that may have been given will be considered as a confirmation according to ex Art. 1385 of the Italian Civil Code.

GUARANTEE: Every product was manufactured with the most suitable materials for their intended use. Autohome's quality control is marked by a series identification number that identifies the product, and guarantees an article without defects. Should defects be evidenced, the client may avail of the two-year guarantee, starting from the date the product was delivered. It will however be the Seller's duty to check the basis for the complaint of product defect, which must be relayed according to the deadlines and terms provided by laws. In case of a positive verification, the Seller shall provide for repairs, if possible, or replacement of the defective material. The guarantee shall not cover the defects caused by improper use or normal wear. The shipment costs will be borne by the Client, except when otherwise agreed. For more information, visit www.autohome-official.com.

WITHDRAWAL: The customer is granted fourteen days to withdraw from the remote contract or from the contract not agreed within the commercial premises, with no reason required and cost-free.

WARNINGS: To best appreciate and correctly use the products, we recommend that instructions and warnings accompanying the product be properly read. Please remember that any element applied on the tent will alter the normal conditions of the vehicle. Therefore, the speed must be suitably reduced. The manufacturer declines any liability in case of accidents that may arise due to improper use.

OFFICIAL CATALOGUE: The official catalog has no contractual value. Colors, weights and measurements are given approximatively. The Seller and the Producer reserve the right to make any technical, esthetic and construction changes without any prior notice. Any disputes regarding the sales contract will be settled by the Court of Mantua. In cases where the buyer is a consumer, reference will be made to the local authorities as foreseen by law.

AUTOHOME: Is the brand that identifies the range of products and accessories made in Italy by Zifer Italia s.r.l. – Viale Risorgimento n. 23, 46017 Rivarolo Mantovano (MN).

Autohome® Internationally Registered Trademark no. 886239



AUTOHOME

An Italian company which embraces a precise industrial philosophy based on solid values of consistency, reliability and transparency.

- Supports Made in Italy products
- Furthers technological research
- Selects only top quality materials
- Produces respecting the environment
- Designs using professionals with adventure professionals in mind
- Promotes beauty and design
- Inspires adventure and life outdoors



5* YEARS GUARANTEE

Every single Autohome product has been studied in detail and carried out by utilizing the most suitable materials for its expected use. The fifty-year experience concerning the products allowed the Company to choose suitable materials tested in any different weather and travel conditions.

Strict "Autohome Quality" controls assure that the product is faultless both concerning materials and construction.

*see notes in the instructions given with the product or ask for information: e-mail: info@autohome.it

The tents used the world over by Tour Leaders and Explorers, for extreme car rallies and expeditions, are identical to the standard production: the same product anybody can buy.

Each Autohome roof tent is marked by a Serial Number (label on the internal side of tents' inlet door), which distinguishes the tent and indicates the quality controls it has undergone.

It is recommended to carefully read the general instructions for use and maintenance, which are an integral part of the product and are supplied within its packaging. Pay attention not to lose them! In case of loss, ask for them to the point of sale or to info@autohome.it



AUTOHOME-OFFICIAL.COM



5
YEARS
WARRANTY



[WEB SITE]



[CATALOGUE]

(EN)

Any dispute will be dealt with only by the Court in Mantova, Italy.
© Zifer Italia S.r.l. - Any reproduction or partial reproduction is strictly forbidden without the written consent of Zifer Italia S.r.l. - Viale Risorgimento, 23 - 46017 Rivarolo Mantovano (MN) - Italy. Any infringement of intellectual property rights will lead to legal action which may result in prosecution.

PRINTED IN ITALY - AUGUST 2024

PRICE LIST SEPTEMBER 2024(EN) VAT EXCLUDED

AUTOHOME®

AUTOHOME® produced by
Zifer Italia Srl
Viale Risorgimento, 23
46017 Rivarolo Mantovano
(Mantova) Italy
Tel. +39 0376 99590
+39 0376 958164
Fax +39 0376 958088

AUTOHOME-OFFICIAL.COM
info@autohome.it

MADE IN ITALY

Autohome-Official